

# FOREST<sup>®</sup>

DRAPERY HARDWARE



**CKS<sup>®</sup>**  
*Corded Klick System*

# CKS<sup>®</sup> Corded Klick System

## Product information

- Highly efficient cord traversing system with separate internal cord channels; preventing cord sag and eliminating cord tangle.
- Quick installation with "Smart Klick" brackets for wall and ceiling applications.
- Bendable; it can be curved and reverse curved by using a 10 cm (4") radius or continuous curved.
- Heavy duty clickable carriers -UV protected - for smooth and easy traversing. Offset shape for straight hanging pleats.
- Can also be used for ripplefold or accordiafold drapery systems.
- Maximum fabric weight:  $\pm 6$  kg per meter (4,5 LBS per ft.).
- Colours available: white and silver.
- Available lengths: 4 meter (13'1"), 5 meter (16'4"), 6 meter (19'8").
- Track finish: chromated powder coated with a factory applied patented dry lubricant.
- Limited lifetime warranty.

## For use in

Hotels - offices - residences - boats - campers - planes or any location where an efficient cord traversing system is required.

## Applications

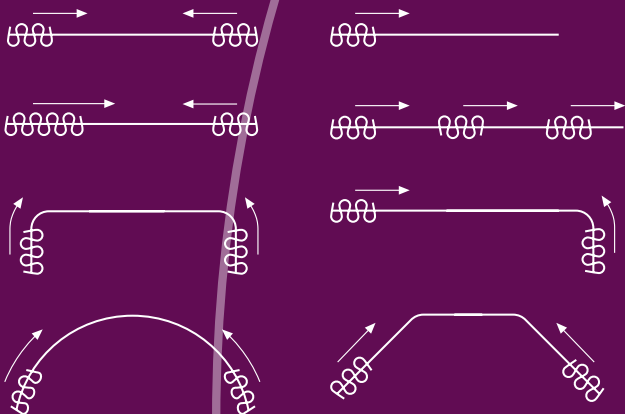

Bending and assembly instructions available on request

## Bending/ curving

The track can be curved and reverse curved using a 10 cm (4") radius. Continuous curving can easily be done using the continuous curver or the electric powered bender.

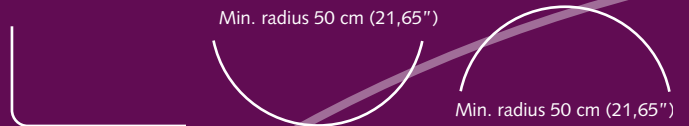

## Profile

- Shown actual size 1:1
- Aluminium Extrusion
- Weight: 202 grams per meter (2.17 ounce per ft.)
- Dimensions: 14 mm x 20 mm (0,6" x 0,8").

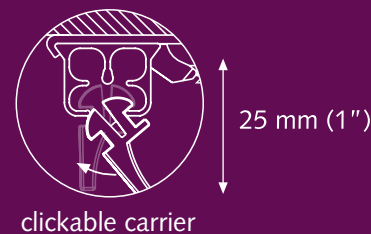
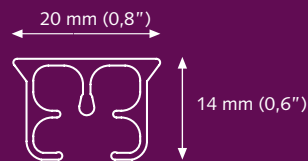

Easy installation  
click - position - tighten

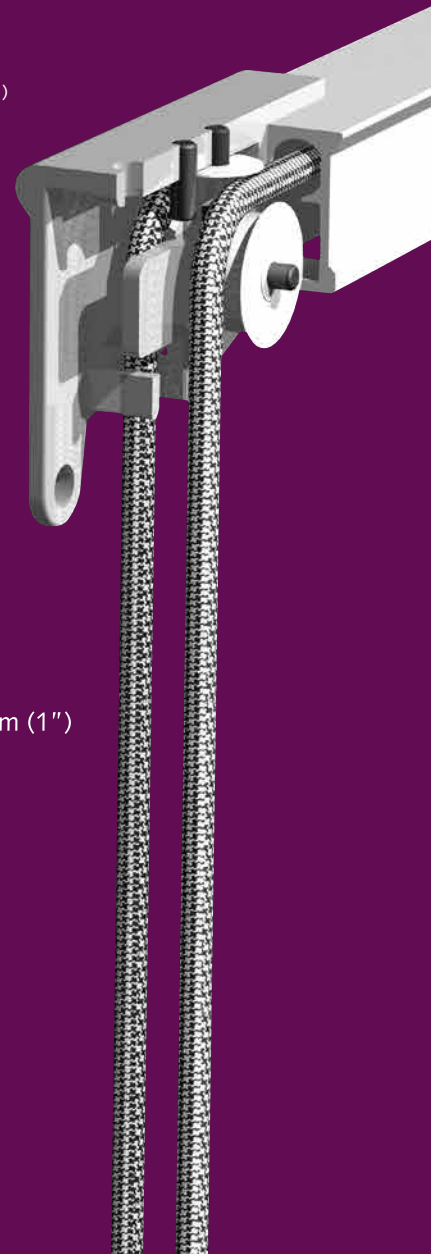

# Mounting Brackets

- ① CKS Track
- ② KS Carrier
- ③ CKS Master Carrier Overlap
- ④ CKS Master Carrier Underlap
- ⑤ CKS Pulley

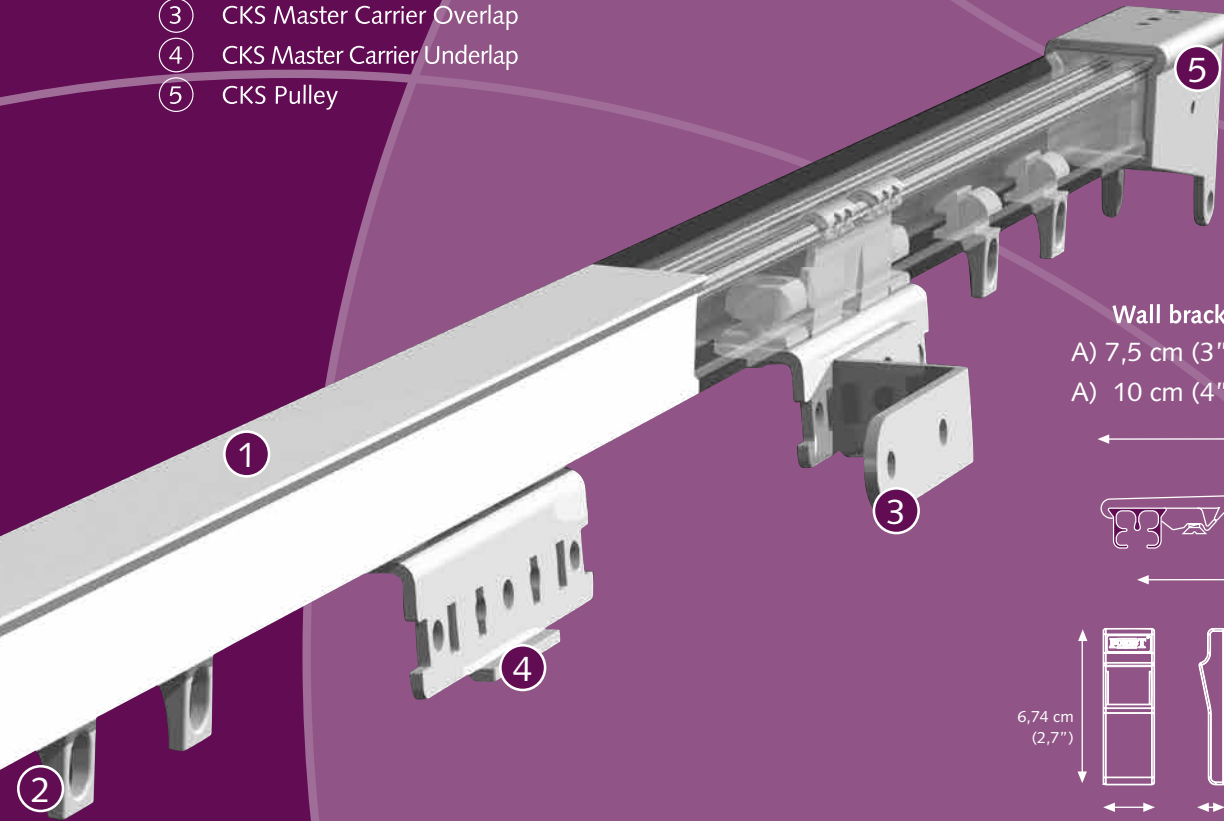

Ceiling Bracket

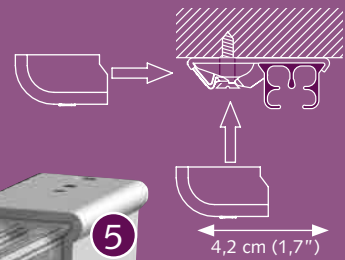

Wall bracket aluminium single

- A) 7,5 cm (3''), B) 6,3 cm (2,5'')
- A) 10 cm (4''), B) 8,8 cm (3,5'')

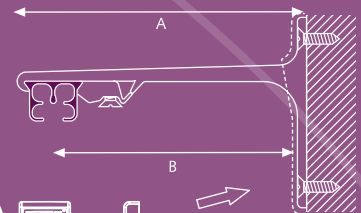

Wall bracket

- 3,5 cm (1,4''), 6 cm (2,4'')

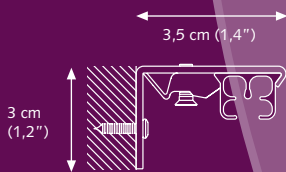

- A) Min. 10 cm (4'')



- A) Min. 15 cm (6'')



Wall bracket aluminium double

- A) 15 cm (6''), B) 9,2 cm (3,6''), C) 4,5 cm (1,8'')
- A) 20 cm (8''), B) 9,2 cm (3,6''), C) 9,5 cm (3,7'')

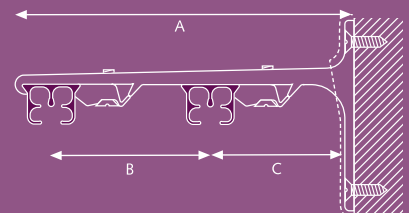

Wall bracket aluminium triple

- 25 cm (10'')

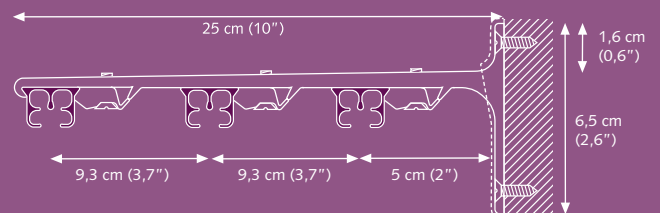

Other brackets are available. Brackets need to be placed every 60 cm (24'').

**Colours available from stock:**

Complete the art.nr. with the indicated colour-code

**01 White      06 Black**  
**03 Silver**

Other colours can be delivered on request.

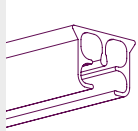
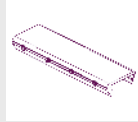
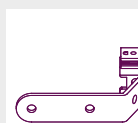
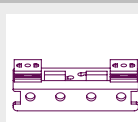
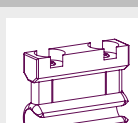
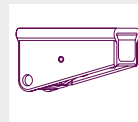
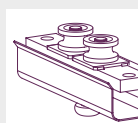
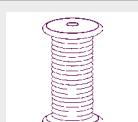
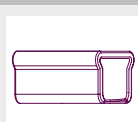
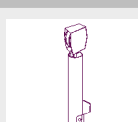
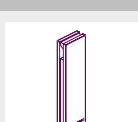
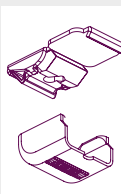
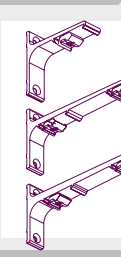
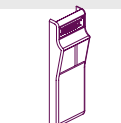
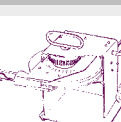
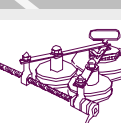
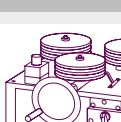
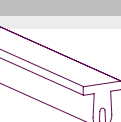
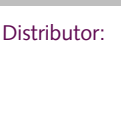
**CKS Track** 15010.. .00 cm  
Aluminium extrusion, powder coated, lubricated. Colours 01, 03 & 06.  
Available lengths: 4 m. (13'1"), 5 m. (16'4"), 6 m. (19'8").  
Silver only in 5 meter length**KS/DS/CKS Track Joiner** 1018401010  
Available in the colours: 10/box  
01, 03 and 06.**Carrier** 10100..000  
"Klickable", offset, constructed of UV resistant plastic. 10 Carriers on a break-away strip. Can be clicked in after installation. Colours: 01, 03 & 06. 500/box**CKS Master Carrier Overlap** 15157..000  
Will go through curves. Available in the colours: 25/box  
01, 03 and 06.**CKS Master Carrier Underlap** 15156..000  
Will go through curves. Available in the colours: 25/box  
01, 03 and 06.**CKS Cord Connector** 1530301000  
Connects cord to the CKS Master Carrier. Colours: 01 100/box  
**CKS Cord Connector Half** 1530311000  
Connects cord to the CKS Master Carrier. Colours: 01 100/box**CKS Pulley** 15301..000  
Reversible, for two way draw. Available in the colours: 25/box  
01, 03 and 06.**CKS Center Pulley** 1530101020  
to join two equal sized tracks in the middle, to create lengths > 6 meter. (19' 18") 25/box**Traverse Cord** 1030401000  
Nylon drapery cord designed for strong smooth slide, Ø 3.5 mm (0,14") 250 mtr/roll  
16 ply. White**CKS End Pulley White Short** 1530101011  
Especially for one-way closing of the curtain. Available in white & silver. 25/box**Tension Pulley** 1030501000  
Plastic, white. 25/box**Cord Chain Weight Design** 10/box  
110 gr  
White 3030701000  
Grey 3030703000  
Black 3030706000**Smart Klick Ceiling Bracket** 10182..000  
"Klicks" onto track, powder coated. 100/box  
Install with counter sunk head screw 4 mm.  
**Inclusive Covercap**  
white 1018201001  
silver 1018203001  
brown 1018205001  
black 1018206001**Smart Klick Wall Bracket** 50/box  
3,5 cm (1<sup>3</sup>/<sub>8</sub>"") and 6 cm (2<sup>3</sup>/<sub>8</sub>"").  
"Klicks" onto track, powder coated. 10202..035  
One screw attachment.  
For light weight use only. 10202..060**Aluminium Wall bracket** 10203.. .000  
Smart klick, powder coated.  
7,5 cm single (3") 20/box  
10 cm single (4") 20/box  
15 cm double (6") 15/box  
20 cm double (8") 15/box  
25 cm triple (10") 10/box**Smart Klick Cover Cap** 10213..000  
**Alu Wall Bracket Universal** 50/box  
Colours: 01, 03.**Compact Bending Tool** 105000000  
For 20 mm (0,8") KS/CRS 1/box**KS/CKS Bending Wheel All-in** 105100000  
For 20 mm (0,8") KS/CRS incl. strips 1/box**Continuous Curver** 1060200000  
Add on tool for the Compact Bending tool. Designed to create continuous curves and arches in any radius. Includes bending strip. For CKS/CKS track only. 1/box**Electric Powered Bender** 1060500000  
Available in 230V or 115V, to create continuous curves and arches. Minimum radius 50 cm (20"). 1/box**CKS Replacement Bending Strip** 1560100000  
For Compact Bending Tool. 1/each  
Length of strip: 60 cm (23")  
For Continues Curver / electric bender. Length of strip: 7 mtr. (23") 1560300000 1/each**KS/CKS Bending Wheels** 1060700000  
For electric powered bender. Complete set of 3 wheels. For CKS/CKS track only. 1/set**Electric Powered Railcutter** 1/each  
230 Volt EU 1061100000  
115 Volt USA 1061200001  
230 Volt UK 1061200002  
**Replacement blade** 1061200000  
For electric powered railcutter. 1/each

Distributor:

**FOREST**  
DRAPERY HARDWARE