

MRS[®]
Motorized Rod System



FOREST[®]
DRAPERY HARDWARE

WEAR-RESISTANT PULLEY HOUSING



For a low-wear operation the pulley housing has been equipped with high-quality ball bearings.

REINFORCED TRANSPORT BELT

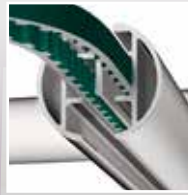

The Kevlar reinforcement of the transport belt ensures a smooth and silent operation, which provides also for a long life-span.

MOTOR



Two types of motors are available:

- 24V Forest Shuttle with touch impulse
- 230V FMS with 45 or 60 Watt

REMOTE CONTROL



Easy opening and closing with the hand-held remote control.

COMPLETELY CLOSED CURTAINS



The overlap carrier guarantees a complete closing of the curtains.

EASY-RUNNING RETURN PULLEY



The special plastic of the return pulley's plain bearing ensures an easy running of the toothed belt.



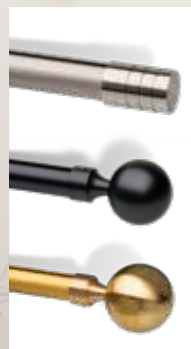



SELECT YOUR INDIVIDUAL FINIAL



Our large range of decorative finials offers you a great variety of design options. But it is also possible to use without a finial.

HIGH-GRADE ALUMINIUM

We supply the special \varnothing 28-mm rods with the following surfaces:

-  White
-  Inox-AN / Inox-PC
-  Anthracite-PC
-  Polished chrome
-  Taupe-PC
-  Antique-PC
-  Gold





SPECIFICATIONS TRACK

- Weight 480 gr / mtr
- Aluminium Extrusion
- Dimension 28 mm



FES[®]
Forest Easyfold System

The Forest Easyfold System[®] is an additional feature of the drapery hardware systems of Forest Group. It complies fully with the contemporary demand for round and fluent shapes in decorative interiors. The easyfold system is also applicable on the MRS motorized rod system[®] and gives a modern and special folding design to the curtain, guaranteed to be a real eye-catcher in every room.

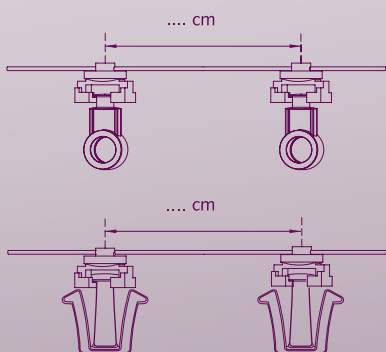

Wave depth 10,75 cm or 15,75 cm with Easysnap tape and carriers. Ceiling space required 10,75 cm or 15,75.

Wave depth fully variable with Easyflex tape and carriers. Ceiling space required is equal to the spacing between the hook placement in the Easyflex tape.

MRS TRACK



5.80 mtr:	
WHITE	5701281580-PC
GOLD	5701282580
INOX-AN	5701283580
INOX-PC	5701283580-PC
TAUPE-PC	5701284580-PC
CHROME	5701287520
ANTHRACITE-PC	5701286580-PC
ANTIQUÉ-PC	5701289580-PC

MRS MOTOR PULLEY LEFT



WHITE	5730101000
GOLD	5730102000
TAUPE	5730104000-PC
ANTHRACITE - PC	5730106000-PC
CHROME	5730107000
INOX-AN	5730108000-AN
INOX-PC	5730108000-PC
ANTIQUÉ-PC	5730109000-PC

MRS MOTOR PULLEY RIGHT



WHITE	5730201000
GOLD	5730202000
TAUPE	5730204000-PC
ANTHRACITE - PC	5730206000-PC
CHROME	5730207000
INOX-AN	5730208000-AN
INOX-PC	5730208000-PC
ANTIQUÉ-PC	5730209000-PC

MRS RETURN PULLEY LEFT



WHITE	5730111000
GOLD	5730112000
TAUPE	5730114000-PC
ANTHRACITE - PC	5730116000-PC
CHROME	5730117000
INOX-AN	5730118000-AN
INOX-PC	5730118000-PC
ANTIQUÉ-PC	5730119000-PC

MRS RETURN PULLEY RIGHT



WHITE	5730121000
GOLD	5730122000
TAUPE	5730124000-PC
ANTHRACITE - PC	5730126000-PC
CHROME	5730127000
INOX-AN	5730128000-AN
INOX-PC	5730128000-PC
ANTIQUÉ-PC	5730129000-PC

CRS WALL BRACKET



Length: 12 cm	58161..28
	10/box
Colours: 01, 02, 03-AN, 03-PC, 04, 05, 07, 09	

CRS WALL BRACKET



Length: 16 cm	582012..28
	2/box
Colours: 01, 02, 03-AN, 03-PC, 04, 05, 07, 09	

CRS WALL BRACKET DOUBLE



Length: 20 cm	582220..28
	2/box
Colours: 01, 02, 03-AN, 03-PC, 04, 05, 07, 09	

CRS WALL BRACKET EXTENSION

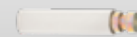

Length: 8 cm	58151..020
	2/box
Colours: 01, 02, 03-AN, 03-PC, 09	

CRS ADJUSTABLE BRACKET EXTENDER



White	5815101070	10/box
Inox-AN	5815103070-AN	
Inox-PC	5815103070-PC	
Antique-PC	5815109070-PC	

CEILING SUSPENSION BRACKET



10 cm (4") bracket	58180.2028
Colours: 02, 03-AN, 03-PC, 05, 09	2/box

CEILING SUSPENSION BRACKET



4 cm (1,6") bracket	58181.2000
Colours: 02, 03-AN, 03-PC, 05, 06, 07	2/box

COLOUR CODES ARE AS FOLLOWS:

01 White 02 Gold 03 Inox-AN 03 Inox-PC 04 Taupe-PC 05 Anthracite-PC 06 Black 07 Chrome 09 Antique-PC

FES/MRS CONNECTOR

Connects the Master Carrier 4805711500
with the transport belt. 25/box



FMS MASTER CARRIER UNDERLAP

Multifunctional - arm is
reversible for Click on stiffner 15/box
White 5215801010
Black 5215806010
Silver 5215803010



FMS MASTER CARRIER OVERLAP

Multifunctional - arm is
reversible for Click on stiffner 15/box
White 5215901010
Black 5215906010
Silver 5215903010



CRS/MRS FINIAL 3 GROOVES

28 mm track 58161..128
Colours: 02,03, 04, 05, 07, 09 2/box



MRS/CRS FINIAL ROUND 60MM

28 mm track, 60 mm 57161..100
Colours: 02,03, 04, 05, 07, 09 2/box



MRS/CRS FINIAL ROUND 70MM

28 mm track, 70 mm 57161..000
Colours: 02,03, 04, 05, 07, 09 2/box



CURTAIN MOTORS AND CONTROLS

For more information about the curtain motors and controls, see our FMS and Forest Shuttle brochures.

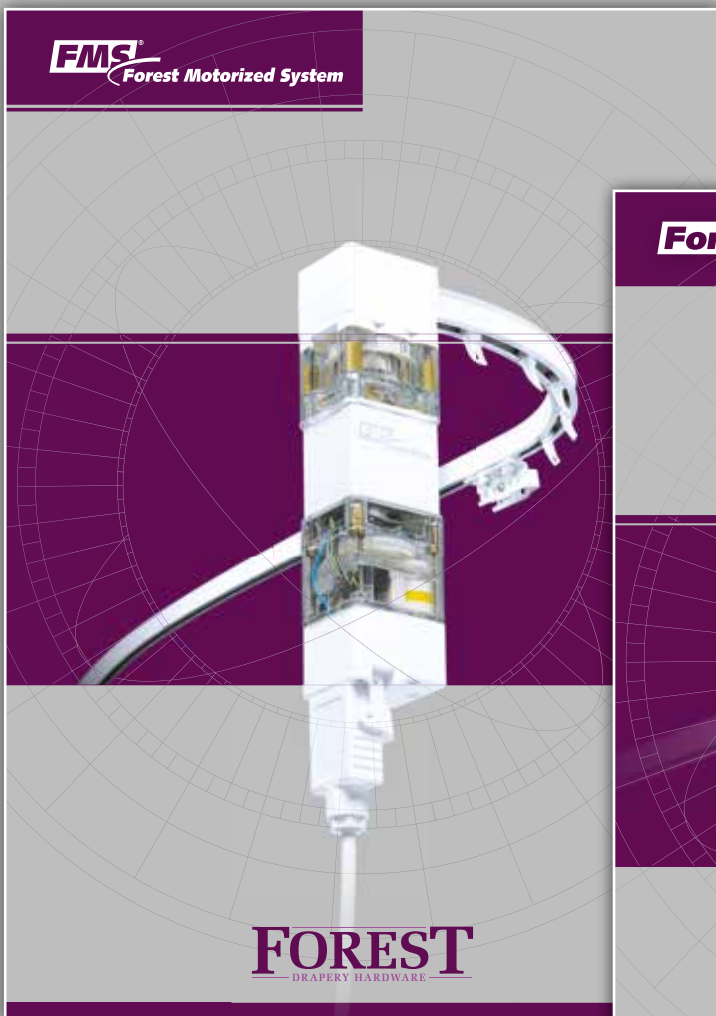

FMS
Forest Motorized System

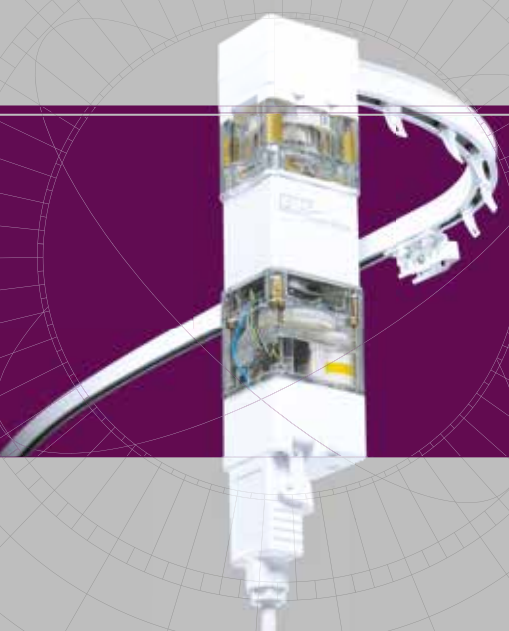

FOREST
DRAPERY HARDWARE



Forest Shuttle

10 year WARRANTY

JUST A GENTLE TOUCH...



REMOTE CONTROL

SILENT TOUCH

OFFICE AUTOMATION

HOTEL AUTOMATION

HOME AUTOMATION

FOREST

FORESTGROUP.COM