

# FOREST<sup>®</sup>

DRAPERY HARDWARE



**CS**<sup>®</sup>  
**Contract System**

## Product information

- Heavy duty hand drawn system for medium and heavy draperies.
- Bendable; it can be curved and reversed curved using a 20 cm (8") radius or continuous curve.
- Heavy duty clickable carriers - 10 carriers on a breakaway strip - UV protected. Can also be used with ball bearing carriers.
- Ideal for use with overlap masters and batons which can be mounted behind or in front of draperies.
- Can also be used for Forest Easyfold Systems and accordiafold drapery systems.
- Maximum fabric weight: 15 kg. per mtr (11,25 LBS per ft).
- Colours available: white, black, silver and brown.
- Track finish: chromated powder coating with a factory applied patented dry lubricant.
- Available lengths: 3.66 m (12'), 4.27 m (14'), 4.88 m (16'), 6.10 m (20')

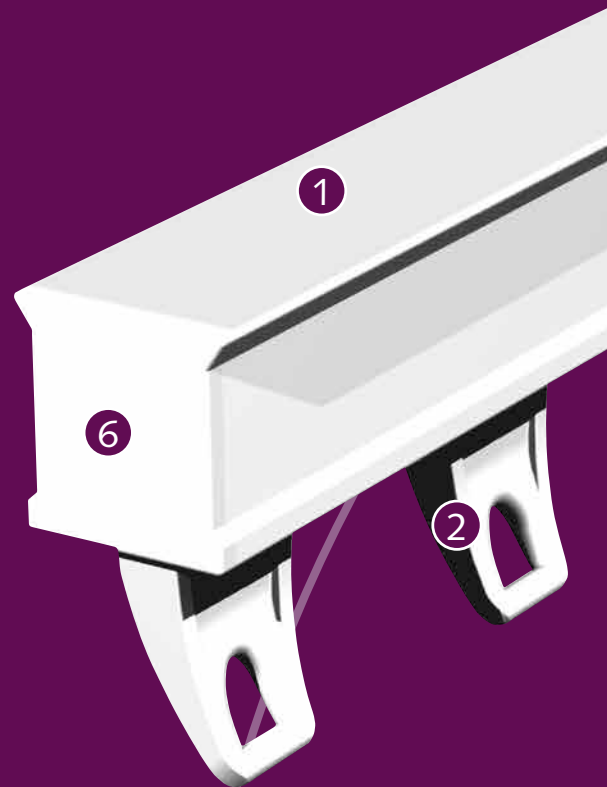

## Applications

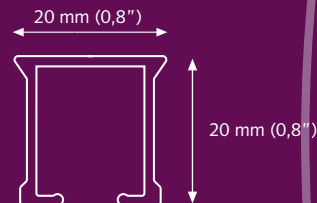
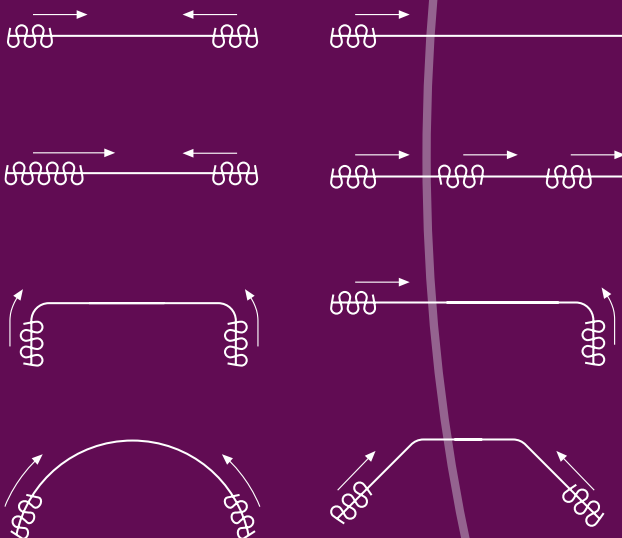

## For use in

Hotels - Motels - offices - schools - healthcare residential or at any location where a heavy duty hand drawn system is required.

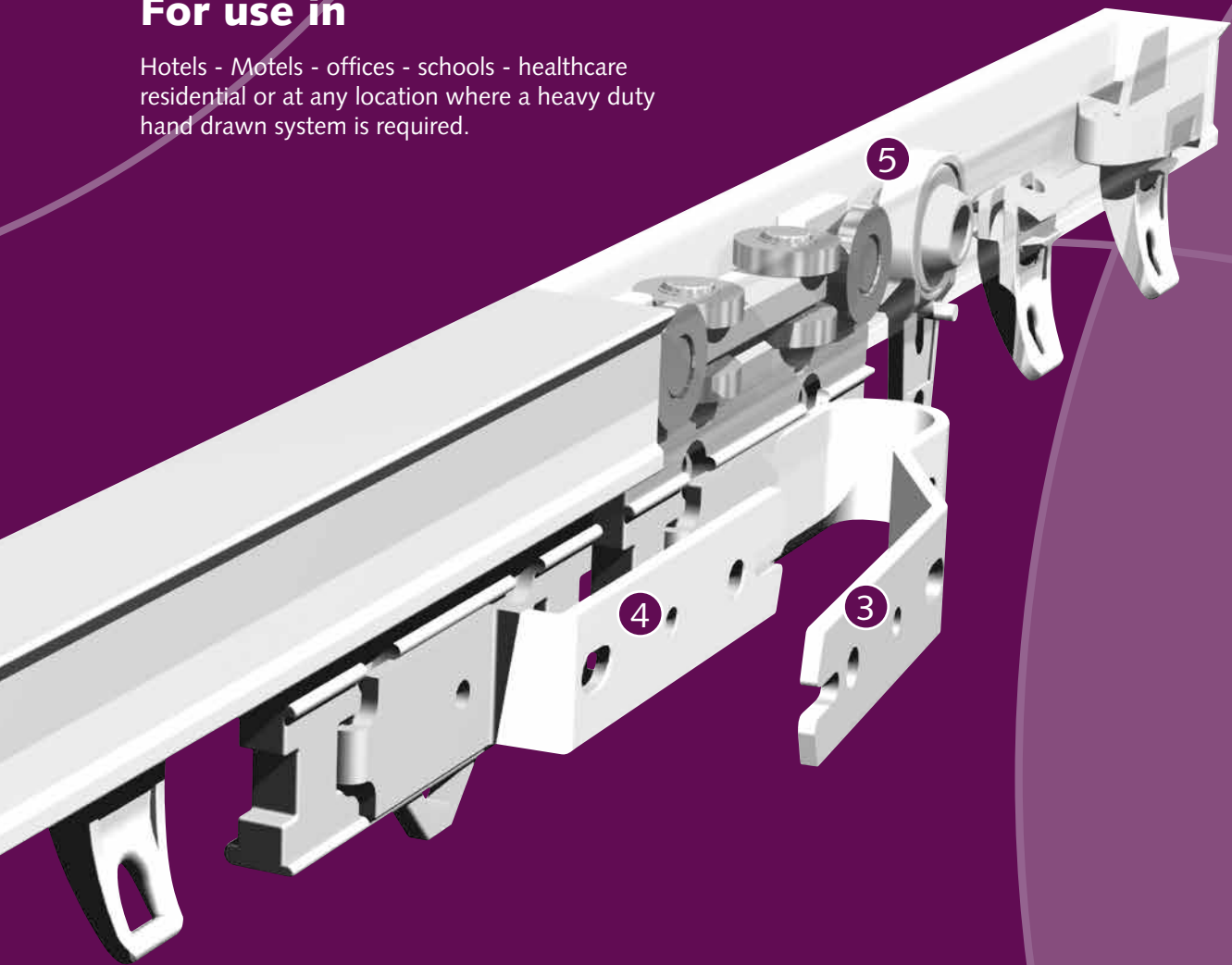

- ① CS Track
- ② Carrier
- ③ Master Carrier R/L Overlap
- ④ Master Carrier R/L Underlap
- ⑤ Carrier
- ⑥ Endcap with screw

## Bending/curving

The track can be curved and reversed curved using a 20 cm (8") radius. Continuous curving is also possible with the electrical bending tool.

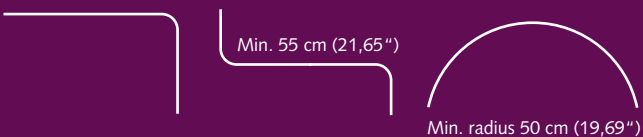

## Click-on Stiffner

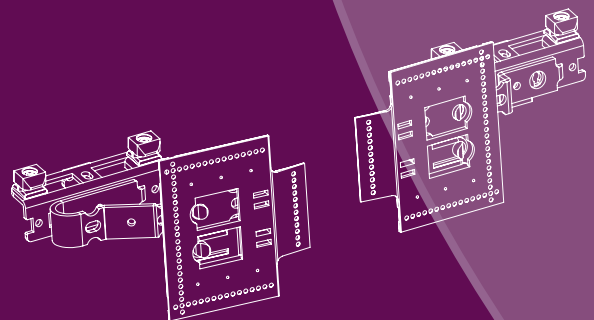

## Mounting Brackets

### Smart Klick Ceiling bracket

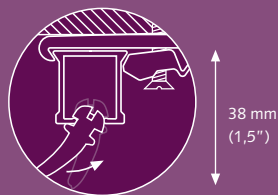
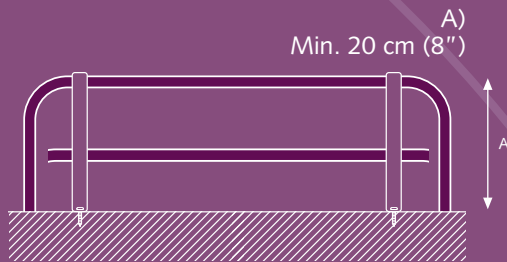
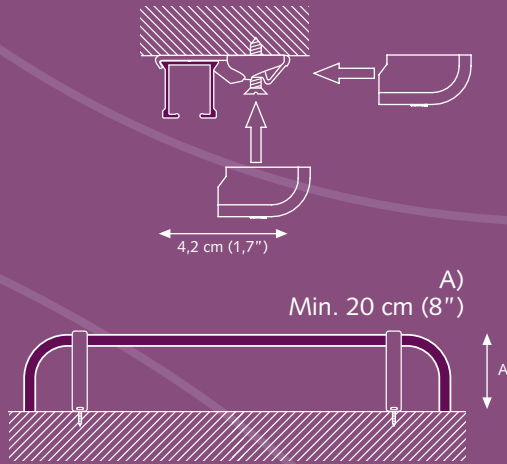

Clickable carrier



Easy installation  
click - position - tighten

## Mounting Brackets

### Aluminium Wall Bracket single

A) 7,5 cm (3") : B) 6,3 cm (2,5")

A) 10 cm (4") : B) 8,8 cm (3,5")

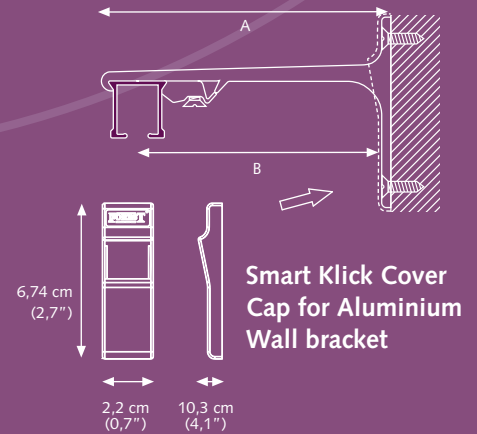

### Aluminium Wall Bracket double

A) 15 cm (6") : B) 9,2 cm (3,6") : C) 4,5 cm (1,8")

A) 20 cm (8") : B) 9,2 cm (3,6") : C) 9,5 cm (3,7")

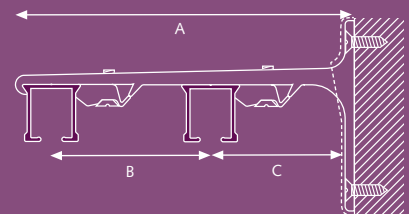

### Aluminium Wall Bracket triple

25 cm (10")

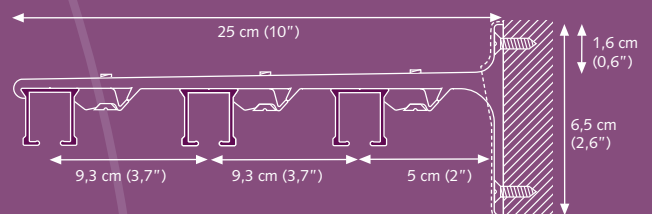

Brackets need to be placed every 50 - 60 cm (24"), depending on fabric weight.

**Colours available from stock:**

Complete the art.nr. with the indicated colour-code

**01 White, 03 Silver, 05 Brown, 06 Black**

Other colours can be delivered on request.

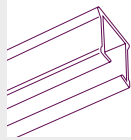
**CS Track**

Extruded aluminium chromated, powder coating, factory lubricated. Available lengths 3.66 m. (12'), 4.27 m. (14'), 4.88 m. (16'), 6.10 m. (20').

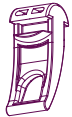
25010...cm  
10/bundle**Carrier**

"Klickable", offset, constructed of UV-resistant plastic. 10 Carriers on a break-away strip. Can be clicked in after installation. Colours: 01, 02, 03, 05, 06.

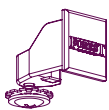
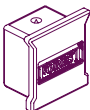
25101...000  
250/box**CS Stop Carrier**Clickable.  
Colours: 01, 03.25102...000  
100/box**CS Carrier with Hook**Clickable.  
Colours: 01.25105...000  
100/box**Economy Slide**Can turn in the track.  
Colours: 01.2510601000  
500/box**Ball Bearing Carrier**25 mm White  
20 mm White  
20 mm Black  
16 mm White  
16 mm Black100/box  
2512100000  
2512000000  
2512006000  
2512000016  
2512006016**Endcap long with screw**Colours: White  
Silver  
Brown  
Black100/box  
2516400000  
2516403000  
2516405000  
2516406000**Endcap short with screw**

Colours: 01, 03, 05, 06.

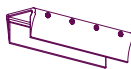
25164..001  
100/box**CS/CCS/FMS Track Joiner**

Used to make a solid connection between two pieces of track.

25184..000  
10/box

Colours 01, 03, 05, 06.

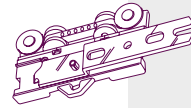
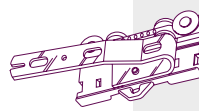
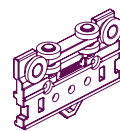
**Master Carrier R/L**Underlap right or left.  
Suitable for heavy drapes.  
Colours: 01.2514600000  
25/box**Master Carrier R/L**Overlap right or left.  
Suitable for heavy drapes.  
Colours: 01.2514700000  
25/box**CS Master Carrier R/L Base**

To be used in combination with any of the following overlap arms:

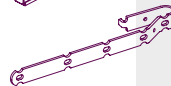
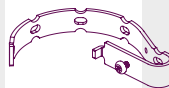
2514500000  
25/boxProlonged Overlap Arm R/L  
150mm for click-on stiffner9500001010  
15/box

Easyflex Curved Arm R/L

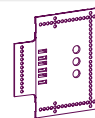
5135901020  
15/box15Z-Arm Universal 175mm White  
R/L9500001030  
15/box**Click-on Stiffner**

Recommended for additional stability of the curtain heading, to be clicked onto the master carrier arm.

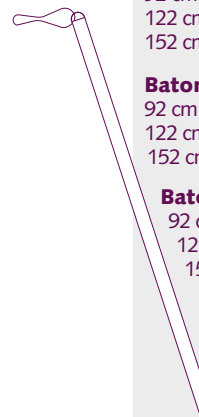
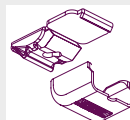
5116001001  
15/box**Baton Fiberglass White**92 cm (36")  
122 cm (48")  
152 cm (60")1065101...  
100/box**Baton Transparent**92 cm (36")  
122 cm (48")  
152 cm (60")1065102...  
50/box**Baton Aluminium**92 cm (36")  
122 cm (48")  
152 cm (60")White  
Silver  
Black  
Antique1065111...  
1065113...  
1065116...  
1065119...  
50/box**Smart Klick Ceiling Bracket**"Klicks" onto track, powder coated.  
White included cover cap  
Silver included cover cap  
Black included cover cap100/box  
1018201001  
1018203001  
1018206001

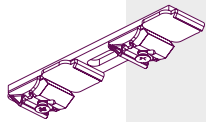

**Smart Klick Double Ceiling Bracket Large** 1018601000  
Distance between two tracks: 90 mm (3,5") 30/box

**Smart Klick Double Ceiling Bracket Short** 1018611000  
Distance between two tracks: 45 mm (1,8") 30/box



**False Ceiling Bracket (metal)** 100/box  
For installation on to a suspended ceiling. The track can be fixed in any angle. 4519001000



**Aluminium Wall Bracket** 10203.. ... mm  
Smart klick, powder coated.

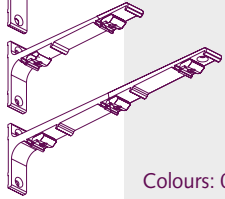

7,5 cm single (3") 20/box  
10 cm single (4") 20/box  
15 cm double (6") 15/box  
20 cm double (8") 15/box  
25 cm triple (10") 10/box

Colours: 01, 03.

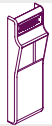

**Smart Klick Cover Cap** 10213..000  
**Alu Wall Bracket Universal** 50/box  
Colours: 01, 03, 06.

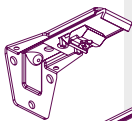

**Adjustable Wall Bracket** 10208..115  
Smart Klick, adjustable single from 7,5 cm (3") to 11,5 cm (4.5") 100/box

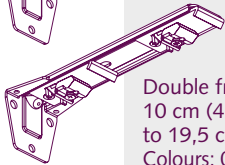

Double from 6,5 cm (2,5") to 10 cm (4") - 15 cm (6") 10208..195  
to 19,5 cm (7,5") 50/box  
Colours: 01.



**MTS Suspension Ceiling Bracket** 4518201000  
Length: 10 cm (4") - 1 m (3,3') 4518201500  
1 m (3,3') - 1,5 m (4,9') 1/each

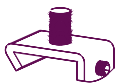

**Suspension Bracket Clip** 1016901000  
To be used in combination with the Suspension Ceiling Bracket 50/box



**Velcro Hotel Profile** 3581601600  
Inside frame fix, to reduce light leakage in combination with Looptape 120 mtr/bundle  
3816202020 25 mtr/roll

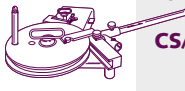

**Contract Bending Tool** 2560000000  
For CS/CCS/FMS/CRS/MTS 1/each

**CS/CCS/FMS Bending Wheel** 2561000000  
1/each

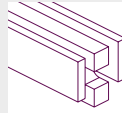

**CS Bending Strips** 8500000001  
For CS track, length: 90 cm (35,4") 1/set

For CS electric powered bender. Length 7 meter (23'). 5160600000 1/set

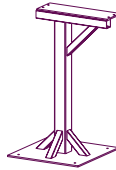

**Bending Stand** 2560800000  
Stand for contract bending tool 1/each

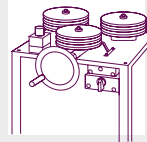

**Electric Powered Bender** 1060500000  
Available in 230V or 115V, to create continuous curves and arches. 1/box  
Minimum radius 50 cm (20").



**Bending Wheels** 2560700000  
For Electric Powered Bender. Complete set of 3 wheels. 1/set

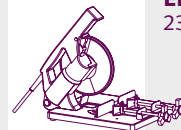

**Electric Powered Railcutter** 1061100000  
230 Volt EU 1/each

**Replacement Blade** 1061200000  
For electric powered railcutter. 1/each



**Forest Lubricant** 5109010000  
To lubricate components during assembly. 1/box

Distributor:

**FOREST**  
DRAPERY HARDWARE

